

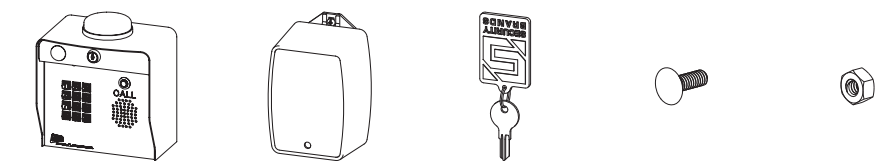

1 Carefully unpack box and make sure you have all of the components shown below.



Ascent Unit 12-V AC/DC Adapter (PS-12DC1) Key Carriage Bolt (x4) Hex Nut (x4)

IMPORTANT!

We recommend mounting Ascent on a gooseneck pedestal using included hardware.

If using alternate mounting, two (2) **Ascent 10' Cable Extension (p/n 16-X-EXT)** products should be purchased and installed.

Failure to do so may result in NO SIGNAL!

2 Unlock and open front panel of unit for wiring and setup.

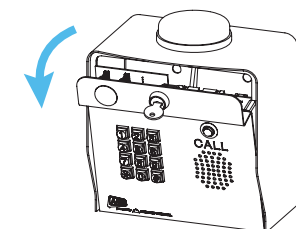

Continued on next page...

IMPORTANT!

Ascent **WILL NOT WORK** until the activation process is **COMPLETE!**

Follow the **Activation Guide** or call **Summit Control at (844) 259-8265** to activate your unit.

WARNING!

AUTOMATIC GATES CAN CAUSE SERIOUS INJURY OR DEATH!

ALWAYS CHECK that the **GATE PATH IS CLEAR BEFORE OPERATING!**

Reversing or other safety devices should **ALWAYS BE USED!**

What's what?

Important components labeled

Unit shown with front panel fully open. Internal wiring not shown for clarity.

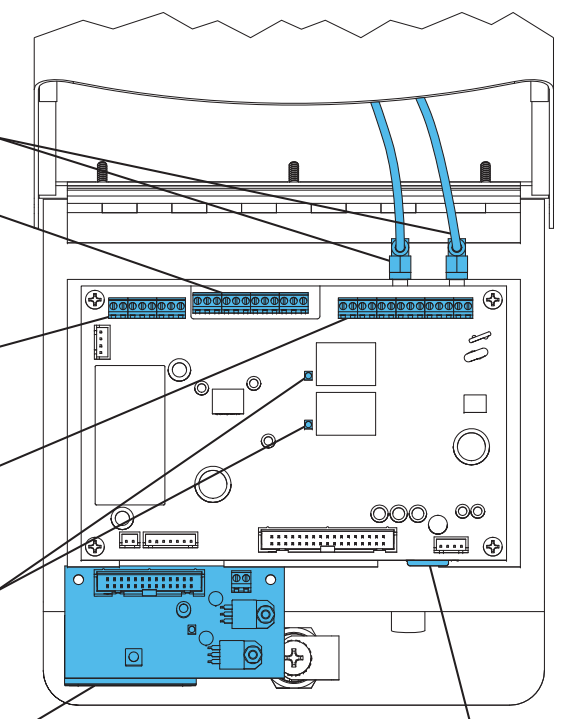

- Antenna Cables**
- Wiegand Device Terminals**
For wiring to Wiegand-compatible devices. See summitcontrol.com/resources.
- Status and Event Terminals**
For wiring to check gate status and for request-to-exit devices. See Page 3.
- Power and Relay Terminals**
For wiring to power and gate operator and/or door opener. See Page 2.
- Relay Status LEDs**
Relay is active when lit
- Ascent Camera**
For automatic and on-demand photo capture
- SIM Card**
If you have your own SIM card, see Page 4 and follow the instructions entitled, **Installing a Third-Party SIM Card.**

CAUTION!

Please use **all four screws** when mounting unit to pedestal. Leave "hockey puck" antenna in place, even if using extension. Seal any holes or gaps created in unit enclosure.

Failure to follow these instructions can result in damage to the unit!

3 Connect wires

Feed wires through back of unit and connect as shown.

Additional wiring diagrams can be found on **Page 3**.

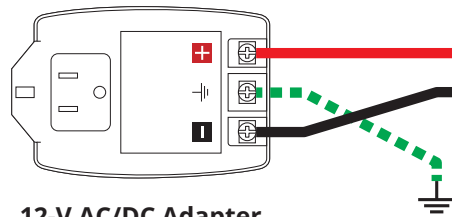

12-V AC/DC Adapter
(Model PS-12DC1 included)

The GROUND terminal is optional unless required by local code(s). If using, please connect to earth ground or equivalent.

OR

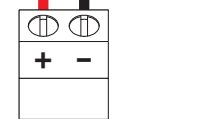

Third-Party 12-24-VAC/DC Power Source

Ascent Power and Relay Terminals

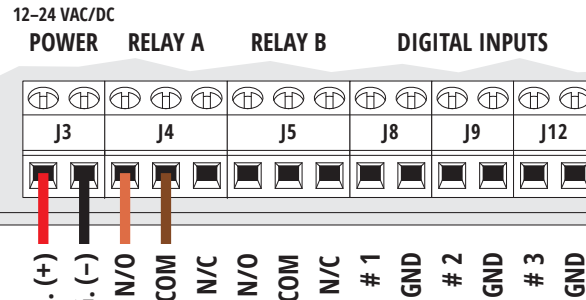

Gate Operator / Door Opener

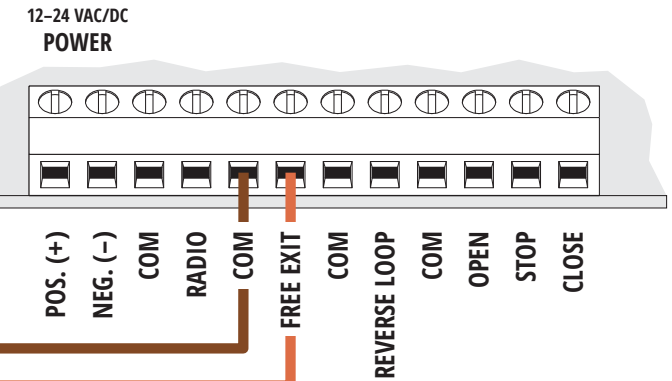

Relay B can be wired to a second device in the same manner.

CAUTION!

If you will not be using the 12-V AC/DC adapter, please go to **Page 4** and follow the procedure, **Using a Third-Party Power Source**.

Do not exceed 24 VAC/DC! Failure to choose a compatible power source can damage unit!

STOP!

Before going forward, double check wiring and ensure unit has power!

For additional wiring options, see **Page 3**.

4 Close and lock front panel.

5 Make sure gate path is clear, then key in temporary code 2012 on keypad and confirm gate opens.

2 0 1 2

Adding and deleting codes is done through Summit Control and **NOT** from the keypad!

INSTALLATION COMPLETE!

Now follow the **Activation Guide** to create an account and begin using Ascent.

A Status Check

Wiring to enable Gate Status Check

Ascent Status and Event Terminals

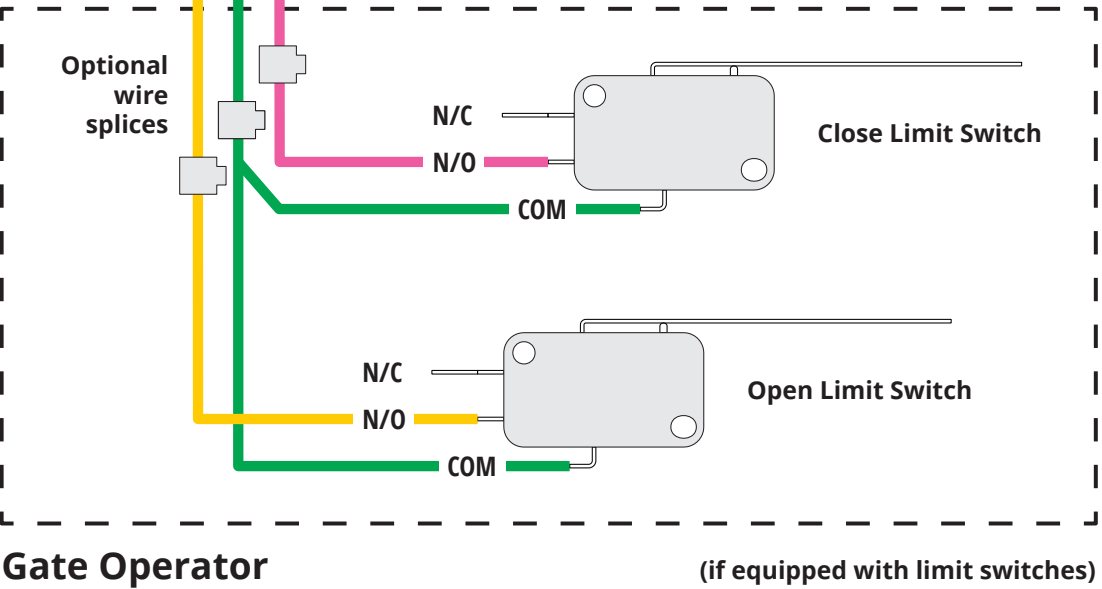
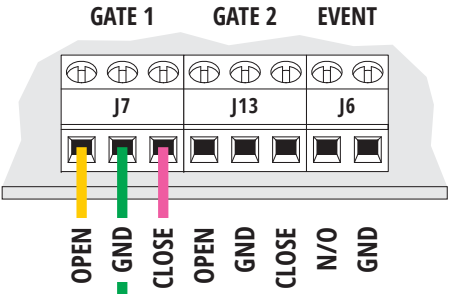

B Event Input

Wiring for accessories such as a request-to-exit device

Ascent Status and Event Terminals

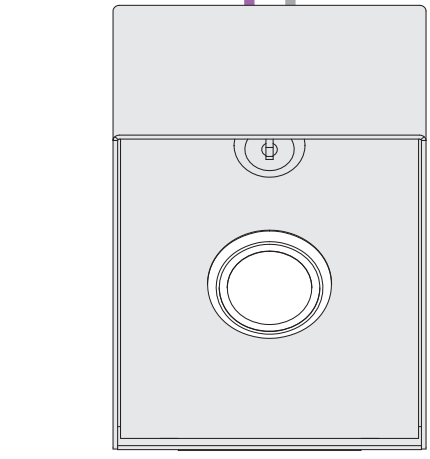
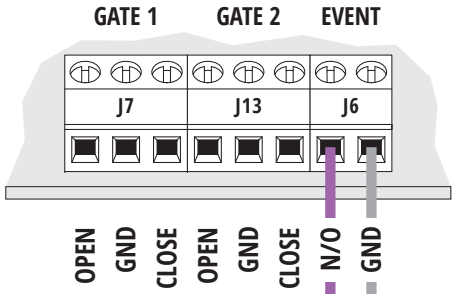

Request-to-Exit
(Summit Access Control S-RTE-P is shown)

Using a Third-Party Power Source (Optional)

IMPORTANT!

If you would like to use a third-party power source, such as solar, verify that it conforms to the following specs:

Input	12–24 VAC/DC no more than 10% beyond this range
Current Draw	less than 90 mA @ 12 VDC less than 60 mA @ 24 VDC

3a Connect wires to unit as shown in Step 3.

3b Connect wires to your power source, making sure you connect positive to positive and negative to negative.

CAUTION!

Double check that you've wired from positive on Ascent to positive on your power source and negative on Ascent to negative on your power source.

Reverse polarity can damage Ascent!

Installing a Third-Party SIM Card (Optional)

1 Push existing SIM card in until it unlocks with "click" sound.

2 Remove existing SIM card and locate new SIM card.

3 Insert new SIM card until it locks in place with "click" sound.

? NEED HELP

Call (844) 259-8265

Email support@summitcontrol.com

We are available **Mon-Fri / 8am-5pm Central**



SECURITY BRANDS INC
your *partner* in access control