

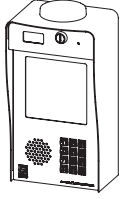



**1** Unpack box and make sure you have all items shown here.



Ascent Unit



12-V AC/DC Adapter



Key



Carriage Bolt  
(4x)



Hex Nut  
(4x)

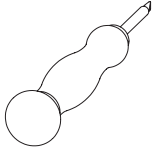

Screwdriver

**IMPORTANT**

This Ascent unit **WILL NOT WORK** until the activation process is **COMPLETE!**

See the included **Activation Guide** to get this unit activated.

If you need help or have any questions, please contact **Summit Control** at **(972) 474-6422**.

**WARNING**

**AUTOMATIC GATES CAN CAUSE SERIOUS INJURY OR DEATH!**

**ALWAYS CHECK THAT THE GATE PATH IS CLEAR BEFORE OPERATING!**

**REVERSING OR OTHER SAFETY DEVICES SHOULD ALWAYS BE USED!**

**2** Unlock and open unit faceplate for mounting, wiring, and setup.

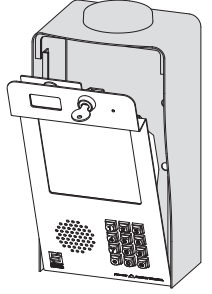

**IMPORTANT**

We recommend mounting the unit on a gooseneck pedestal using the included mounting hardware.

If using alternate mounting, the **4G LTE Antenna Extension Kit (Model 16-ANTX-1)** should be purchased and installed.

**Failure to do so may result in NO SIGNAL!**

**CAUTION**

Use all four carriage bolts when mounting the unit to a pedestal.

Leave the "hockey puck" antenna in place even if using an antenna extension.

Seal all openings created in the enclosure.

**Failure to follow these instructions can damage the unit!**

**3** Mount unit to pedestal using included mounting hardware. (This step may be completed later.)

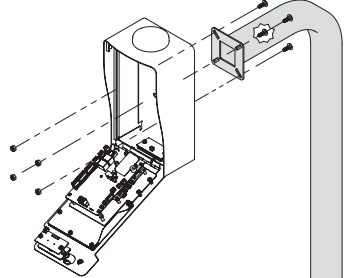

## What's what?

All important components labeled

Unit shown with faceplate fully open. Internal wiring not shown for clarity.

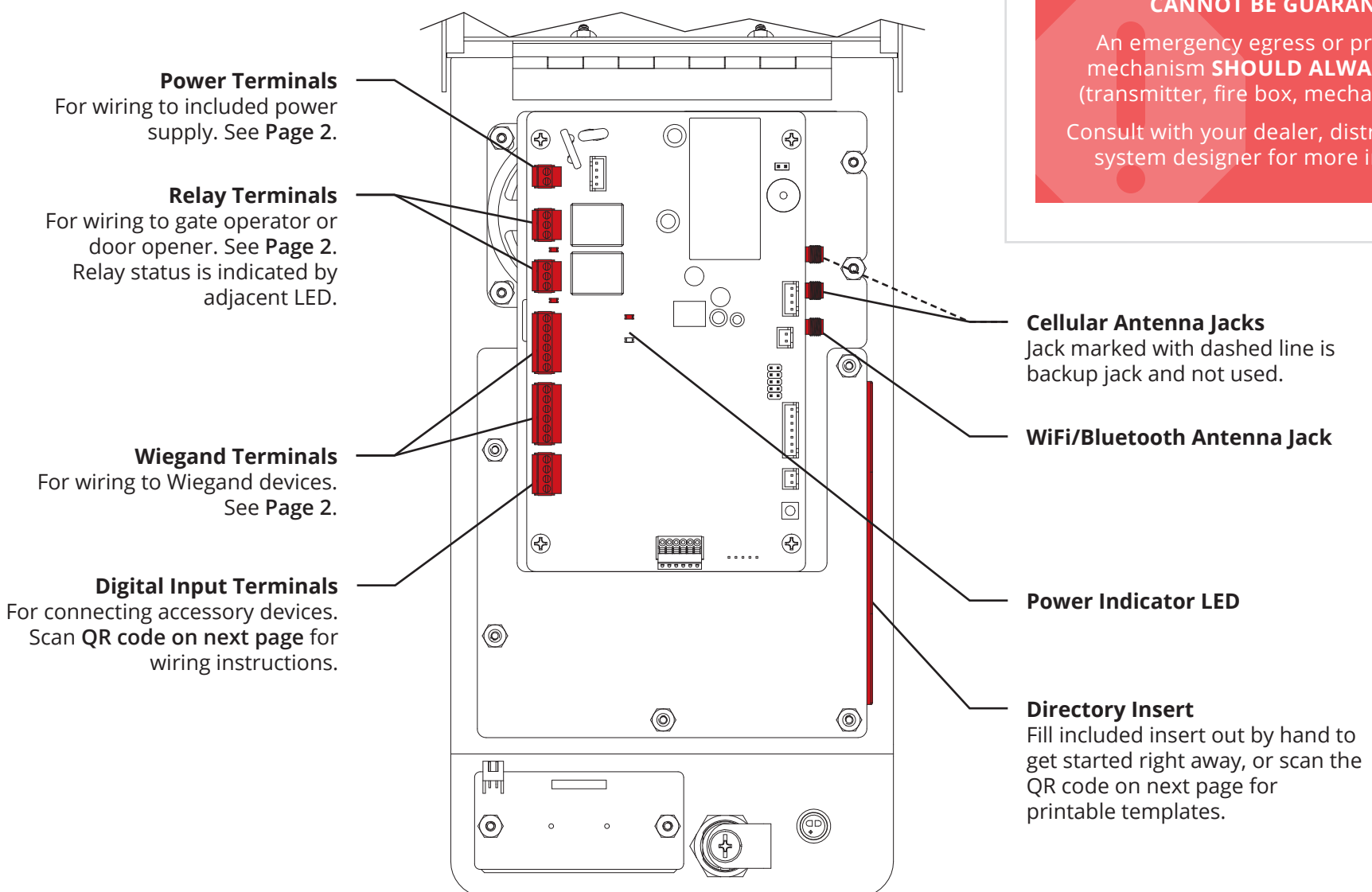

**STOP**

This is a cellular accessory for a gate or door. An uninterrupted cellular connection **CANNOT BE GUARANTEED!**

An emergency egress or primary entry mechanism **SHOULD ALWAYS BE USED!** (transmitter, fire box, mechanical release)

Consult with your dealer, distributor, and/or system designer for more information.

**NEED HELP**

Call (972) 474-6422  
Email [support@summitcontrol.com](mailto:support@summitcontrol.com)  
We are available **Mon-Fri / 8am-5pm Central**

Flip page to continue...

## 4 Connect wires

Feed wires through back of unit, and connect as shown using included screwdriver.

Consult gate/door opener manual for exact connections. Terminals vary widely across manufacturers and models.

Additional wiring diagrams can be found below and online.

**CAUTION**

When connecting the power supply, remember to connect positive to positive and negative to negative to avoid damage.

**Reversing polarity can damage the unit and void the warranty!**

We recommend using 18-gauge stranded wire for all connections.

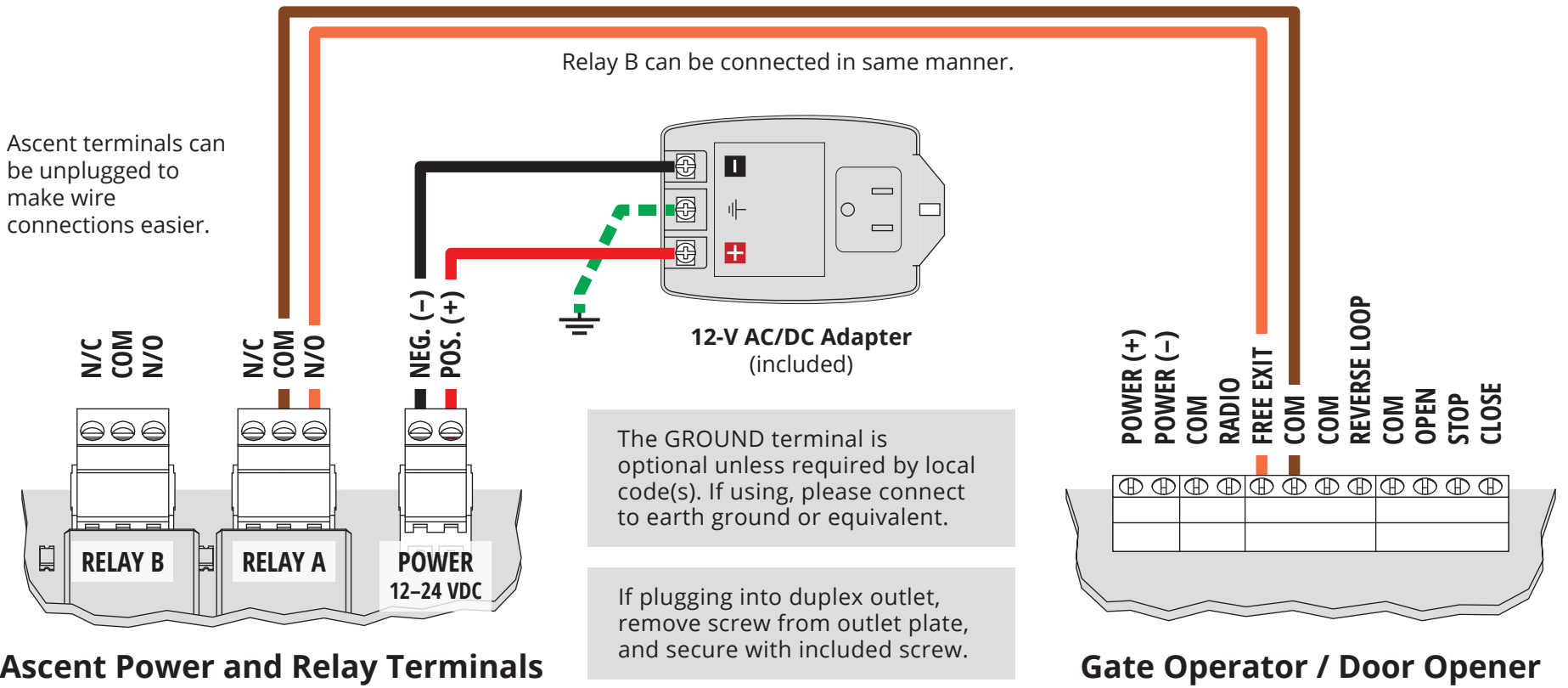

**STOP**

Before going forward, double check all wiring and make sure the unit has power!

A wiring diagram for connecting to Wiegand devices can be found below.

For connecting accessories not mentioned, please scan the QR code on this page.

**Make sure the gate path is clear before completing Step 5!**

**5** Key in temporary code 2012 on keypad and confirm gate opens. If it does, close and lock unit faceplate.

2 0 1 2

Adding codes is done in online dashboard and **CANNOT** be done using keypad on unit!

**INSTALLATION COMPLETE!**

Now follow the **Activation Guide** to create an account and begin using Ascent.

## A Wiegand Device

Feed wires through back of unit, and connect as shown using included screwdriver.

These terminals are used to connect a Wiegand device such as a card reader or Wiegand keypad.

Either set of Wiegand terminals can be used for wiring and then configured in the online dashboard.

**CAUTION**

Disconnect power to the Ascent unit before connecting Wiegand devices.

**Failure to disconnect power can damage the unit!**

**Need More?**

Use the QR code below for printable directory insert templates and more resources, including how-to videos and additional wiring diagrams for connecting accessory devices.

