

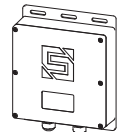



1 Carefully unpack box and make sure you have all items shown below.
(Screwdriver not shown)



Ascent Unit



12-V AC/DC Adapter
(PS-12DC1)

STOP!

This is a cellular accessory for a gate/door, so an uninterrupted cellular connection **CANNOT BE GUARANTEED.**

An emergency egress or primary entry mechanism **SHOULD ALWAYS BE USED** (transmitter, fire box, mechanical release).

Consult with your dealer, distributor, and/or system designer for more information.

2 Remove screws and cover of unit for access to internal components.

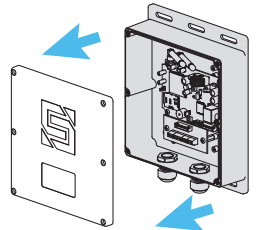

Continued on next page...

What's what?

Important components labeled

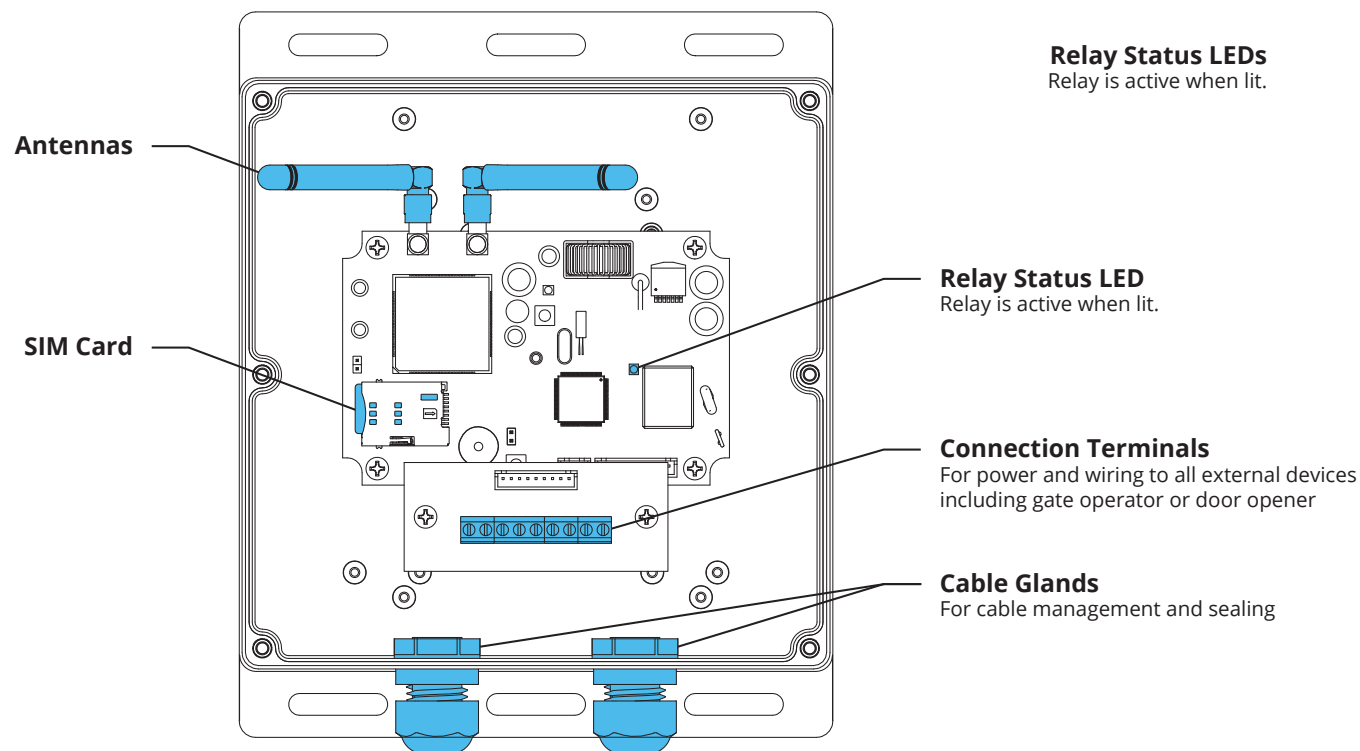

IMPORTANT!

Ascent **WILL NOT WORK** until the activation process is **COMPLETE!**

Follow the **Activation Guide** or call **Summit Control at (844) 259-8265** to activate your unit.

WARNING!

AUTOMATIC GATES CAN CAUSE SERIOUS INJURY OR DEATH!

ALWAYS CHECK that the **GATE PATH IS CLEAR BEFORE OPERATING!**

Reversing or other safety devices should **ALWAYS BE USED!**

3 Connect wires

Feed wires through cable gland(s) on unit and connect as shown using included screwdriver.

Excessive force can damage unit.

Ascent Connection Terminals

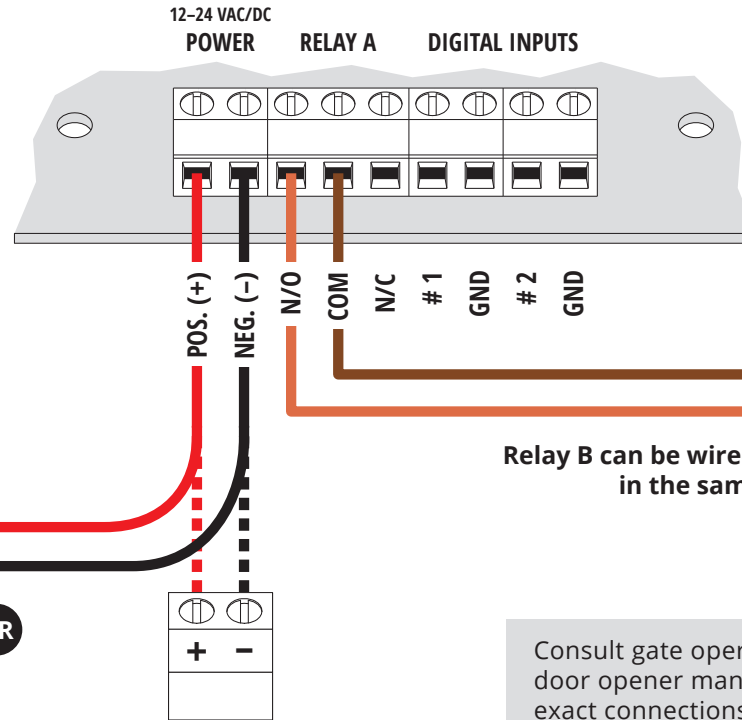

Gate Operator / Door Opener

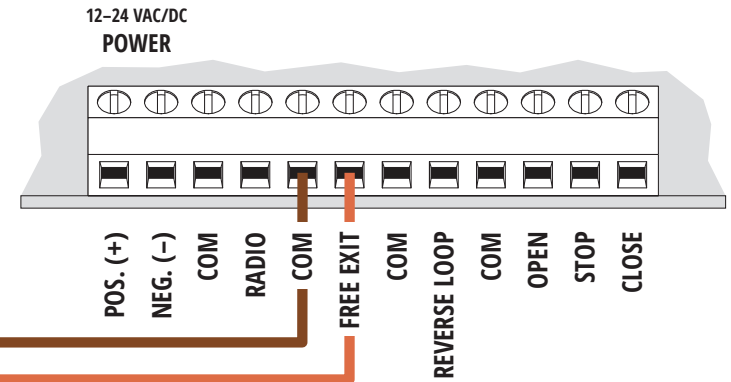

If plugging into duplex outlet, remove screw from outlet plate, and secure with included screw.

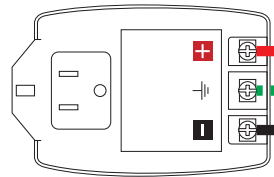

12-V AC/DC Adapter
(Model PS-12DC1 included)

The GROUND terminal is optional unless required by local code(s). If using, please connect to earth ground or equivalent.

OR

Third-Party 12-24-VAC/DC Power Source

Relay B can be wired to a second device in the same manner.

Additional wiring diagrams can be found on **Page 3**.

Consult gate operator or door opener manual for exact connections. Terminals vary widely across manufacturers and models.

CAUTION!

If you will not be using the 12-V AC/DC adapter, please go to **Page 4** and follow the procedure, **Using a Third-Party Power Source**.

Do not exceed 24 VAC/DC! Failure to choose a compatible power source can damage unit!

STOP!

Before going forward, double check wiring and ensure unit has power!

For additional wiring options, see **Page 3**.

4 Tighten cable-gland locknut(s).

5 Replace and secure front cover with included screws.

INSTALLATION COMPLETE!

Now follow the **Activation Guide** to create an account and begin using Ascent.

Using a Third-Party Power Source (Optional)

IMPORTANT!

If you would like to use a third-party power source, such as solar, verify that it conforms to the following specs:

Input	12–24 VAC/DC no more than 10% beyond this range
Current Draw	less than 260 mA @ 12 VDC less than 160 mA @ 24 VDC

3a Connect wires to unit as shown in Step 3.

3b Connect wires to your power source, making sure you connect positive to positive and negative to negative.

CAUTION!

Double check that you've wired from positive on Ascent to positive on your power source and negative on Ascent to negative on your power source.

Reverse polarity can damage unit!

IMPORTANT!

We recommend mounting Ascent inside the gate operator or other weatherproof enclosure when possible.

If mounting inside a metal enclosure, the **4G LTE Antenna Extension Kit (p/n 16-ANTX-1)** should be purchased and installed.

Failure to do so may result in no signal!



NEED HELP

Call (844) 259-8265

Email support@summitcontrol.com

We are available **Mon–Fri / 8am–5pm Central**



SECURITY BRANDS INC™
your *partner* in access control