

# RTE 300 QUICK START GUIDE

Model S-RTE-300

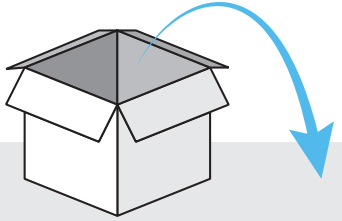

**1** Carefully unpack box.



**2** Make sure all components are present.

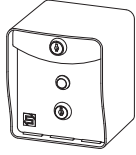

RTE Unit



9-V Battery



Key Switch Keys



Lock Key



Carriage Bolt  
(x4)



Hex Nut  
(x4)



Hole Plug

## What's what?

All the important internal components labeled for you

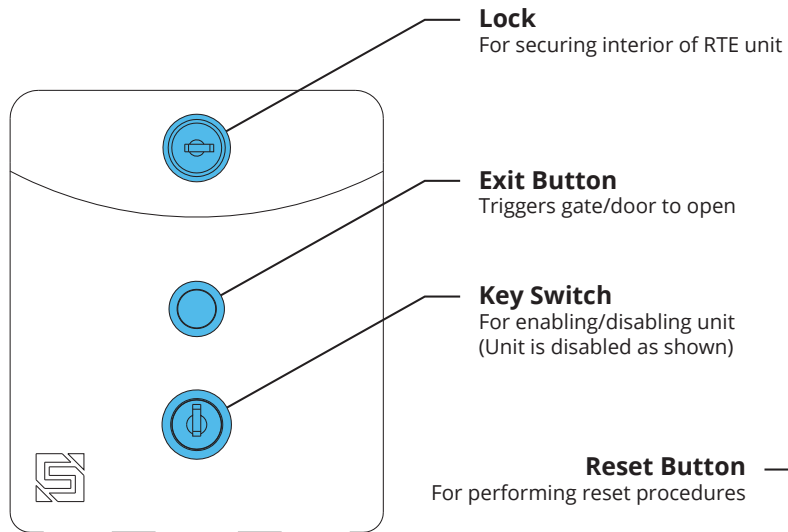

RTE Unit Front Panel (Front)

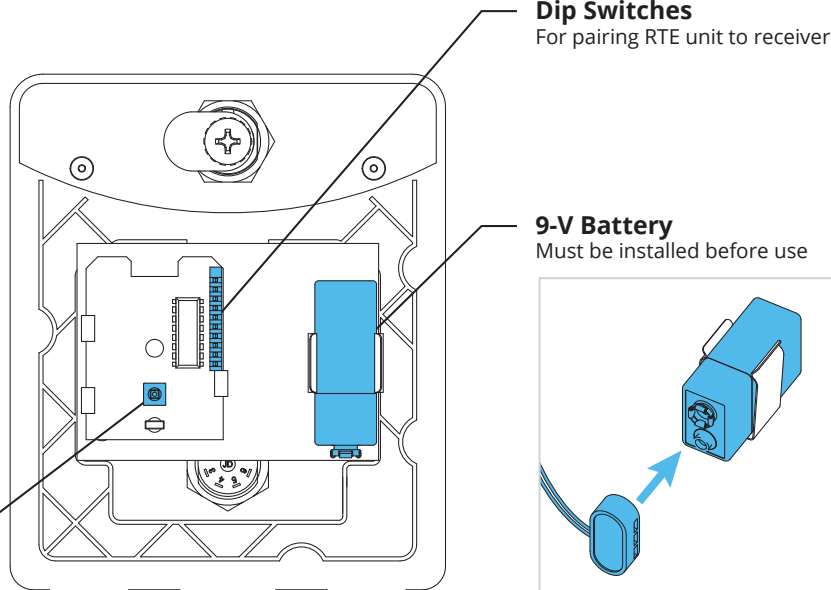

RTE Unit Front Panel (Back)

Internal wiring not shown for clarity.

**3** Unlock and remove front panel of RTE unit, then using carriage bolts and hex nuts, attach unit to pedestal.

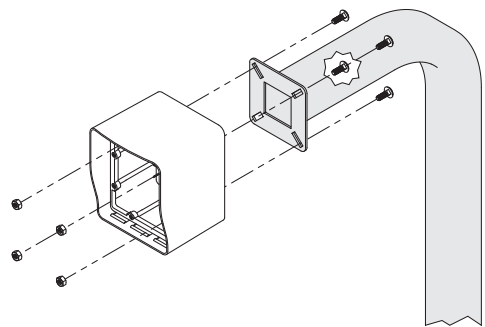

**! WARNING!**

**AUTOMATIC GATES CAN CAUSE SERIOUS INJURY OR DEATH!**

**ALWAYS CHECK that the GATE PATH IS CLEAR BEFORE OPERATING!**

Reversing or other safety devices should **ALWAYS BE USED!**

# RTE 300 QUICK START GUIDE

Model S-RTE-300

**4** Locate receiver (not included) and open for access to DIP switches.

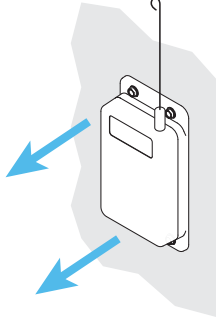

**NOTE:** For a gate installation, the receiver is typically installed inside the gate operator housing.

**5** Carry RTE unit to receiver then set DIP switches on RTE unit to match DIP switches on receiver. Double check for match.

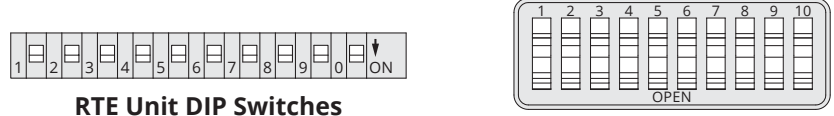

**RTE Unit DIP Switches**

**Receiver DIP Switches**  
(look of components may vary)

1 2 3 4 5 6 7 8 9 0/10

**NOTE:** Use the blanks above to note positions. Use an "X" for ON and leave blank for OFF. DIP switches may be labeled differently. The word, OPEN, means the same thing as OFF.

**6** Make sure gate/door path is clear, then press exit button on RTE unit and confirm gate/door opens.

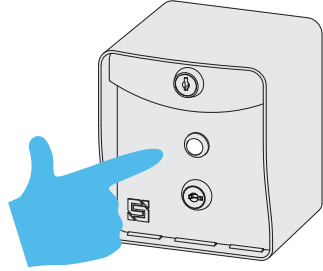

**NOTE:** Key switch must be in the "enabled" position.

**A** RTE unit can be disabled or enabled at any time by using key switch located below exit button.

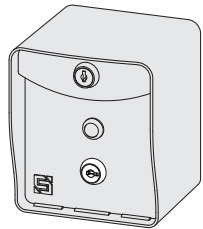

**Unit Enabled**  
(exit button active)

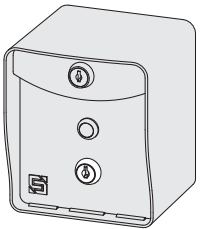

**Unit Disabled**  
(exit button inactive)

**!** **IMPORTANT!**

The RTE 300 is compatible **ONLY** with **300-MHz RECEIVERS** that use **10 DIP SWITCHES**, including those with the Digi-Code or Multi-Code® brands.

This unit **WILL NOT WORK** with any other receivers!

If you are not sure what kind of receiver you have, check with your distributor.



**INSTALLATION COMPLETE!**

Your system is ready to use.

**? NEED HELP**

Call us at **(800) 541-5677**  
or visit [securitybrandsinc.com/contact](http://securitybrandsinc.com/contact)  
We are available **Mon-Fri / 8am-4:30pm Mountain**

 **SECURITY BRANDS INC™**  
your *partner* in access control