

ASCENT M⁴



16-M4

CELLULAR MULTI-TENANT ENTRY SYSTEM WITH 4-LINE LCD

FEATURES

- Large 20x4 LED-backlit LCD directory
- 4G LTE cellular
- High-definition Ascent Camera for still photos
- Photo push notifications
- 2 Wiegand inputs
- Ascent Link integration
- Control up to 2 gates/doors
- Cloud-based access control management
- Up to 10,000 app, text, and voice users
- Configurable keypad code length (4 to 6 digits)
- Rollover calling—up to 3 phone numbers per address
- Push and/or email event and status notifications



powered by  **SUMMIT CONTROL**

GET THE SUMMIT CONTROL APP



SIMPLY EASY

The LCD directory is simple to understand and easy to read, even in bright sunlight.

NO-NONSENSE INTERFACE

Navigating the on-screen resident directory couldn't be any easier for guests. Simply find your party and press the button to call.

POWERFULLY EXPANDABLE

Network multiple Ascent units together and manage multiple entries via Summit Control.

GET CONNECTED EVERY TIME

Assign up to three phone numbers to each address to be called one after the other, ensuring a connection is always made.



SPECIFICATIONS

PHYSICAL

Dimensions 16.55"(H) x 10.50"(W) x 4.74"(D)
 Shipping Weight 17 lbs.

ELECTRICAL

Input 12-24 VAC/DC
 12-VDC power supply included (PS-12DC2)
 Current Draw dependent on user settings
 Unit requires constant power source and is not recommended for solar applications

RELAY

Contact Rating 10 A @ 120 VAC / 24 VDC
 Max Switching Voltage 250 VAC / 30 VDC
 Max Switching Current 15 A
 Max Switching Power 240 W / 2,770 VA

COMMUNICATION

Cellular Network 4G LTE







ENVIRONMENTAL

Operating Temperature -15 to 158 °F

▲ Actual voltage should be no more than 10% beyond specified range. Use of the included 12-VDC power supply is recommended.

CONTROL IT YOUR WAY

2^{DOOR}

-  APP
-  TEXT
-  VOICE
-  KEYPAD*
-  DIRECTORY CALL
-  WIEGAND DEVICES

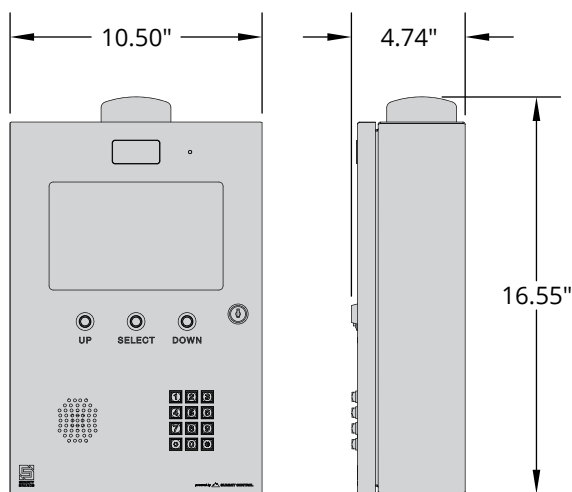

GET STARTED NOW!

PAY JUST **ONE BILL!***

Unit includes a GSM SIM card ready for activation.

We do ALL the legwork for you!



SUMMIT CONTROL

it's that simple!

visit summitcontrol.com



* Because keypad codes are managed via Summit Control, they cannot be added or deleted without an active service plan.

† Monthly bill covers cost of SIM card, actions gateway, servers, maintenance, development, app, and tech support.

For more information, visit us online:
securitybrandsinc.com



SECURITY BRANDS INCTM
 your *partner* in access control