

ASCENT X²



16-X2

CELLULAR MULTI-TENANT ENTRY SYSTEM WITH DIRECTORY INSERT

FEATURES

- Full cellular with automatic network selection
- LED-backlit directory for paper inserts
- HD video event capture with IR for low light
- Time/use-limited QR-code quick access
- Control up to 2 gates/doors
- 2 Wiegand inputs
- Up to 5,000 app, text, and voice users*
- Up to 5,000 keypad codes*
- Rollover calling—up to 3 phone numbers
- Push and/or email event and status notifications
- Cloud-based access control management
- LED downlight and LED-backlit keypad



* Maximum number is dependent on plan.

powered by  **SUMMIT CONTROL**

GET THE SUMMIT CONTROL APP



CALLING MADE EASY

Key in the directory code listed next to the resident you wish to call and the unit calls.

AN ASCENT WITH A VIEW

Enjoy crisp HD video event capture with IR, giving you clear visual ID when you talk to your guests, even in low light.

AN UP-TO-DATE DIRECTORY

As residents come and go, just print off a new insert using our ready-made templates.

GET CONNECTED EVERY TIME

Assign up to three phone numbers to each address, to be called one after the other, ensuring a connection is always made.



SPECIFICATIONS

PHYSICAL

Dimensions	12.55"(H) x 6.50"(W) x 5.15"(D)
Shipping Weight	10 lbs.

ELECTRICAL

Input	12-24 VDC 24-VDC power supply included (PS-24DC2)
Current Draw	less than 330 mA @ 12 VDC less than 160 mA @ 24 VDC with relays latched and LED components on

RELAY

Contact Rating	10 A @ 120 VAC / 24 VDC
Max Switching Voltage	250 VAC / 30 VDC
Max Switching Current	15 A
Max Switching Power	240 W / 2,770 VA

COMMUNICATION

Cellular Network	4G LTE
------------------	--------







ENVIRONMENTAL

Operating Temperature	-15 to 158 °F
-----------------------	---------------

▲ Actual voltage should be no more than 10% beyond specified range. Use of the included 24-VDC power supply is recommended.

CONTROL IT YOUR WAY

2nd
DOOR

-  APP
-  TEXT
-  VOICE
-  KEYPAD*
-  DIRECTORY
-  WIEGAND DEVICES
-  QR CODE

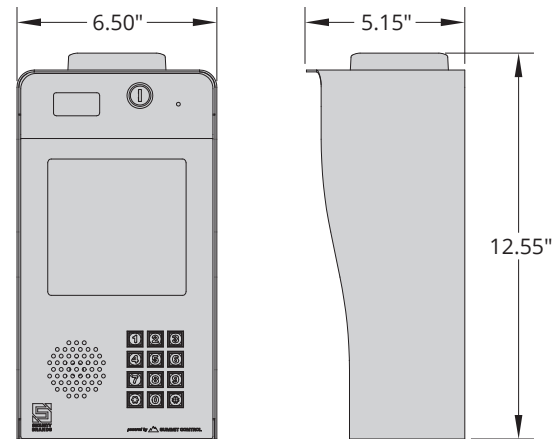

Hole pattern on back for pedestal mounting is spaced at 3.063" with pilot holes for alternate mounting at 2.5".

GET STARTED NOW!

PAY JUST ONE BILL!*

Unit includes a SIM card preinstalled and ready for activation.

We do ALL the legwork for you!



SUMMIT CONTROL

visit summitcontrol.com



* Because keypad codes are managed via Summit Control, they cannot be added or deleted without an active service plan.

† Monthly bill covers cost of SIM card, actions gateway, servers, maintenance, development, mobile app, admin portal, and tech support.

For more information, visit us online:
securitybrandsinc.com



SECURITY BRANDS INC™